

SKO FLO

Pressure Independent
Flow Controller



SkoFlo Valve Model SF15000B

OPERATION AND MAINTENANCE INSTRUCTIONS

SKO FLO INDUSTRIES INC.

SkoFlo Valve Model SF15000B

OPERATION AND MAINTENANCE INSTRUCTIONS

INSTALLATION PROCEDURES:

1. Install valve so that the flow is in the proper direction. The "IN" connection and the "OUT" connection are Autoclave Engineers MP20000 style for 3/8" tubing and are marked respectively. See drawing SF-SK217 for details.
2. Install an inline filter upstream of the SkoFlo Valve. Clean chemical and proper filtering is very important. Omitting the filter can cause the SkoFlo Valve to become plugged. Following are recommended filter sizes:

SkoFlo Dash Number	Filter Micron Size
2 thru 75	40
100 thru 400	90
500 and above	200

START UP PROCEDURES:

1. Back out (rotate counterclockwise) the rate adjustment handle on the flow controller at least three turns.
Note: At this position the flow controller is not controlling (out of range).
2. Open the supply isolation valve to the flow controller **slowly**. This will allow pressures within the flow controller to equalize slowly and valve will stabilize quickly.
3. When flow controller is equalized, turn the rate adjustment handle clockwise until the flow reduces noticeably. Then turn the rate adjustment handle approximately 1/4 turn farther. The flow controller is now controlling at the full rated flow range of the unit.
4. Turn the rate adjustment handle clockwise until you are at the desired flow rate.
5. The flow controller is now set and further adjustments are not required. Tighten the lock nut on the handle to avoid inadvertent changes to the adjustment.

PRINCIPLE OF OPERATION

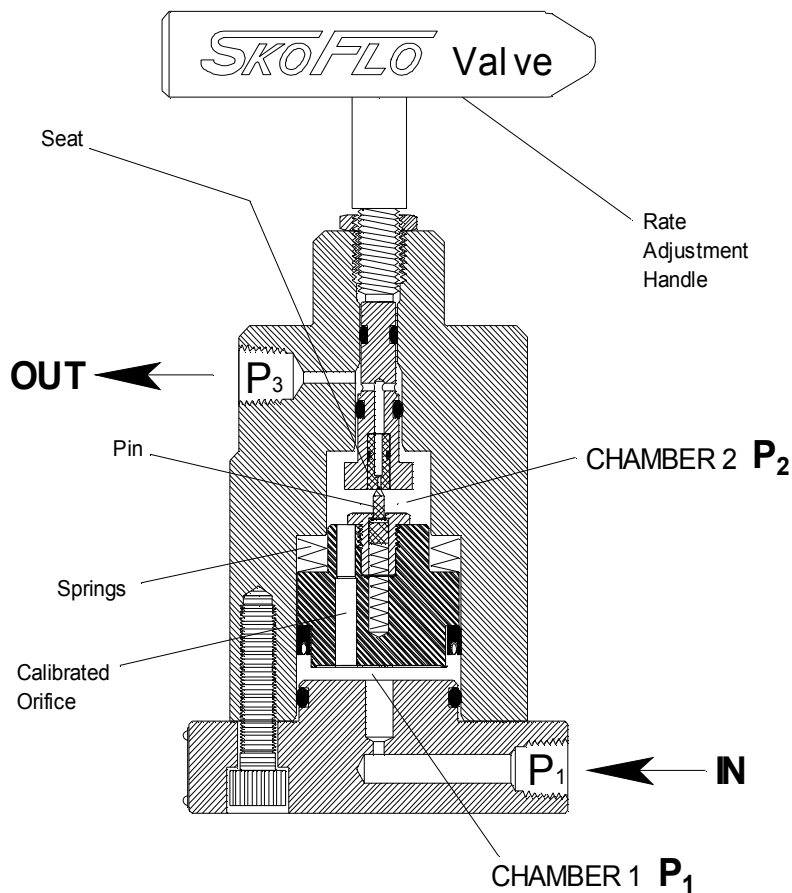

The SkoFlo valve is a pressure independent flow control valve used in the petroleum industry to accurately inject chemicals. The valve consists of a body, a base plate that is bolted to the body, and a flow rate adjustment handle.

The principle of operation of the SkoFlo valve is that it maintains a constant differential pressure across a fixed calibrated orifice, thus resulting in a constant flow through that orifice. We install the orifice into a piston and then use springs to set a constant differential pressure across the piston/orifice assembly, thus maintaining a constant flow. Flow rate changes through the valve can only be made by adjusting the spring force on the piston by turning the rate adjustment handle.

Fluid enters the valve base plate at pressure P_1 . It flows through the base plate into chamber 1. It then flows through a the calibrated orifice into chamber 2 where the springs are located. These springs put a force against the piston based on how much the springs are deflected. The spring force against the piston is set by the rate adjustment handle. This spring force establishes the pressure P_2 in chamber 2. Flow then exits the valve after passing through the seat. The flow through the seat is held back by the pin that mates with the seat. As the pressure builds, the pin moves away from the seat and allows flow to the valve outlet at pressure P_3 . The flow rate remains constant after the equilibrium flow through the valve is established

The SkoFlo model SF15000B valve requires a minimum differential pressure across the valve ($P_1 - P_3$) of 200 psi (14 bar) to achieve full rated flow.

ADJUSTMENT AND CALIBRATION:

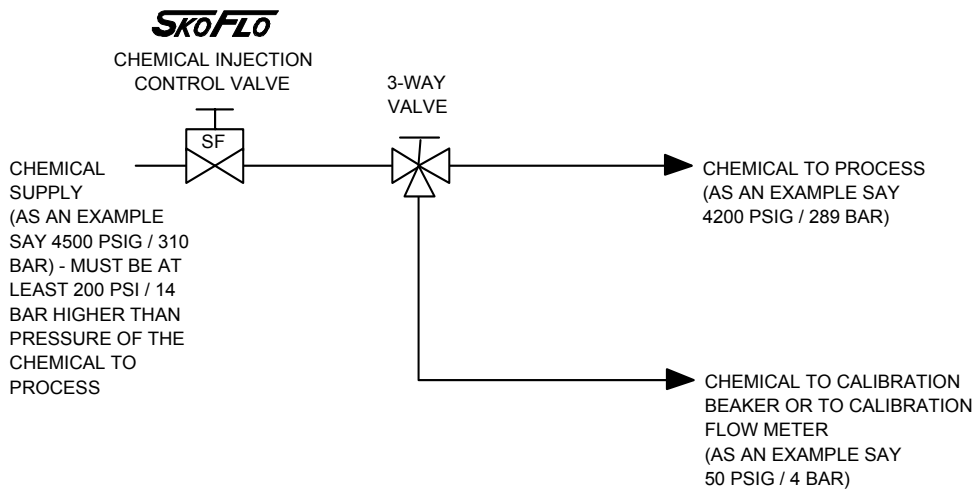

The SkoFlo Valve is a pressure independent flow control valve. Once the valve is set at a desired flow rate, that flow rate is maintained even though the pressure conditions upstream and/or downstream of the valve may change considerably.

The standard Multi-Point SkoFlo valve is set by manually adjusting the rate adjustment handle. When the desired flow rate is set, the lock nut on the handle is tightened down, and the valve remains at that fixed flow rate until the rate adjustment handle is turned to a new setting.

The flow rate can be set using a flow meter in the line to the process. However, a flow meter in this line must be capable of withstanding the process pressure. This normally limits the availability of this type flow meter.

The most common method of calibrating the SkoFlo Valve is with a 3-way valve and a line to a calibration beaker or to a low pressure flow meter. Once the flow rate is set, the 3-way valve is switched to direct the chemical to the process.

Since the SkoFlo Valve flows at the set rate independent of the pressure differential across the SkoFlo Valve, the flow rate to the process is the same as the flow rate set using the beaker or flow meter. Overall monitoring of the flows is done by taking inventory of the usage from the supply tank.

In the above example, the SkoFlo Valve is set with a differential pressure of 4450 psi / 306 bar across the valve. The flow rate set will remain the same when the chemical is routed to process and the SkoFlo Valve has a differential pressure of 300 psi / 21 bar.

OPERATION NOTES AND WARNINGS:

1. The SkoFlo valve has hard seats and is not designed to provide complete "bubble-tight" shut off. Separate isolation valves should be used for shutting off the flow. The SkoFlo valve will reach its minimum flow before the handle is bottomed out. **Overtightening the handle will not further reduce flow**. If flow rate does not decrease when turning the handle in, see "Trouble Shooting Improper Valve Performance".
2. Quick opening or closing of valves upstream or downstream of the SkoFlo valve can cause the internal parts to move extremely fast and flow rate may surge. Valves upstream and downstream should be opened slowly to allow internal pressures to balance and minimize shock to valves and piping.
3. The SkoFlo Valve is designed for flow in one direction only. Do not flow backwards through the SkoFlo valve. Some internal seals are designed for one direction only and could possibly become dislodged. The valve will not control in the reverse direction. SkoFlo Industries recommends installation of a check valve in the outlet line **within 5 feet** from the SkoFlo valve (see "Multi-Point System Sample Schematic") to avoid reverse flow of process fluids into the chemical system.

MAINTENANCE:

1. **Replacing Seals:** When replacing valve seals, it is recommended that the Seat Holder Installer Tool (P/N SF5000-T1), Piston Seal Installer Tool (P/N SF10000-T2) and O-Ring Installation Kit (P/N SF15000-T3) be used.
 - A. Remove SkoFlo valve from system.
 - B. Remove the base cap and the adjustment handle. Slowly push the internal parts out using a rod, hex driver, or similar tool. Use care to avoid damage to the internal surfaces of the SkoFlo valve. (See Figure I).

Figure I

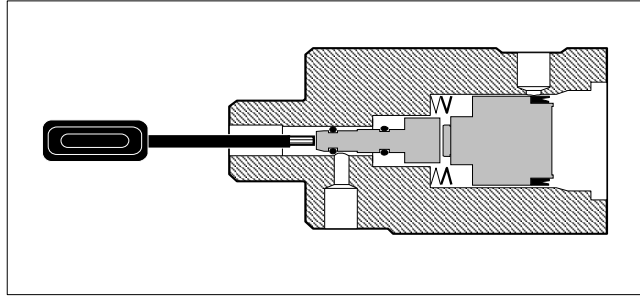

- C. Lubricate new seat holder seals with Parker Super Lube or equivalent. Slide seals onto seat holder using the O-Ring Installation Kit (See Figure II). Install backup ring on low pressure side of o-ring. Make sure the backup ring is lined up at the joint.

Figure II

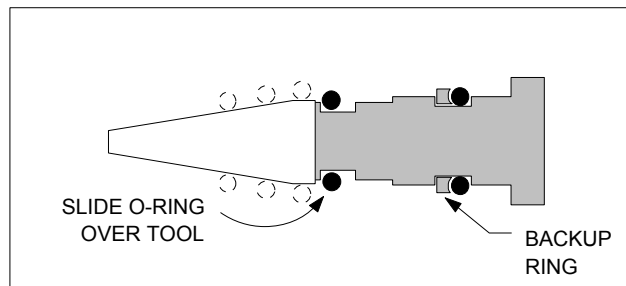

- D. Using large end of Seat Holder Installer Tool, guide seat holder and seal into the body. Use caution not to push too fast which can damage the seal. (See Figure III).

Figure III

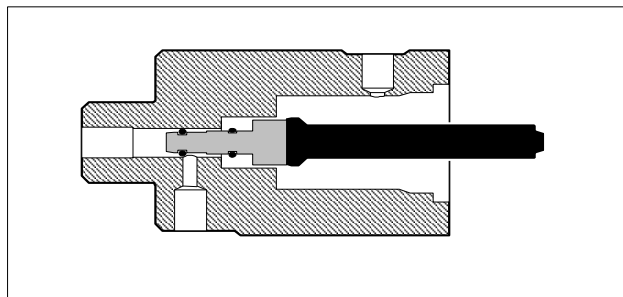

- E. Lubricate piston seal with Parker Super Lube or equivalent. Slide seal onto piston (orient seal correctly). Place piston spring stack on piston/pin holder assembly (orient as shown in "Assembly Section / Parts List"). Carefully slide the complete assembly into the valve body. Do not allow the springs to come off the assembly or they may not line up correctly. Using Piston Seal Installer Tool, push seal and piston into body to clear base cap. (See Figure IV).

Figure IV

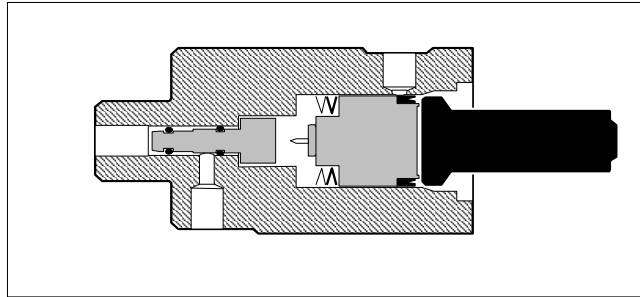

- F. Lubricate base o-ring with Parker Super Lube or equivalent. Place o-ring into o-ring groove of base. Install backup ring on low pressure side of o-ring. Make sure the backup ring is lined up at the joint. Apply anti-seize compound to threads on base cap and screw base cap onto body hand tight. Align cap with set screw hole and install set screw.
- G. Install adjustment handle into the body.

2. **Replacing Seat Holder Assembly:**

- A. Disassemble and reassemble the SkoFlo valve using new seals as described in the "Replace Seals" section above.

3. **Replacing Piston/Pin Assembly:**

- A. Disassemble and reassemble the SkoFlo valve using new seals and piston assembly as described in the "Replace Seals" section above.
- B. When installing pin holder into piston, hold piston in a manner where the surface finish will not be damaged. Torque pin holder to 100 inch-pounds (1.15 kg-m).

5. **Orifice Backflushing Procedure:**

- A. Install seat holder in body with the upper (atmosphere) seal only. (See Figure V).

Figure V

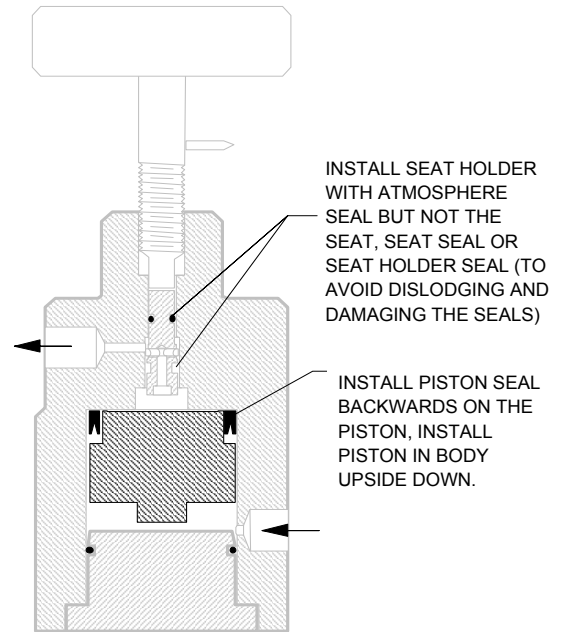

- B. Install the piston seal on the piston backwards from the normal position. (The spring face of the seal will be toward the piston). Install the pin holder in the piston **WITHOUT** the ceramic pin.
- C. Install the piston in the body upside down.
- D. Install the valve base cap.
- E. Apply clean chemical (or water) to the valve inlet. The fluid flow is in the reverse direction to the normal flow thus backflushing the orifice in the piston.
- F. If plugging is not relieved by backflushing, the piston assembly must be replaced.

TROUBLE SHOOTING IMPROPER VALVE PERFORMANCE:

<u>SYMPTOM</u>	<u>CAUSE</u>	<u>REMEDY</u>
1. No Flow	Upstream filter is plugged.	Clean or replace filter element.
	Flow controller orifice is plugged.	Back-flush orifice or replace piston/orifice assembly. Correct cause of plugging such as leaking filter.
	Supply valve is shut off.	Open valve <u>slowly</u> .
	Discharge line is shut off.	Open valve.
2. Fluctuations in flow rates	Rate adjustment handle is backed out past control range (valve is not controlling).	Adjust handle in to set flow as noted in "Start Up Procedures".
	Piston Springs are not installed properly.	Install springs in accordance with drawing SF-0767
	Seat or pin worn or damaged.	Replace seat holder or pin.
	Supply pressure is not adequate.	The flow controller requires a minimum of 200 psi (14 bar) differential pressure across the valve for full rated flow.

<u>SYMPTOM</u>	<u>CAUSE</u>	<u>REMEDY</u>
2. Fluctuations in flow rates (cont.)	Debris between pin and seat.	Remove debris.
	Piston seal dislodged.	Reinstall seal. Avoid reverse flow thru valve.

RECOMMENDED SPARE PARTS:

<u>QTY</u>	<u>PART NUMBER</u>	<u>DESCRIPTION</u>
1	SF5000C-4-(x)	Piston/Orifice Assembly for dash size (x) Valve (Qty 1 for each different dash size)
1	SF15000B-5-STD	Seat Holder with seat (Qty 1 for each 20 valves of dash size 2 thru 75)
1	SF15000B-5-XL	Seat Holder with seat (Qty 1 for each 20 valves of dash size 100 thru 500)
1	SF15000B-5-XLS	Seat Holder with seat (Qty 1 for each 20 valves of dash size 750)
1	SF15000B-5-XXL	Seat Holder with seat (Qty 1 for each 20 valves of dash size 1000 and above)
1	SF15000B-20	Seal Kit (Qty 1 for each 20 valves)

STORAGE:

1. When storing SkoFlo valves prior to first use, it is recommended that the valves be stored indoors. If stored outdoors, apply a light coating of protectant to the exterior of the valve. The shipping plugs in the INLET and OUTLET should remain in place.
2. When storing SkoFlo valves after being in use, dismantle, thoroughly clean and reassemble. Then store as noted in number 1 above.

Please call the factory in Woodinville, Washington USA at phone number (425)485-7816 if you have any questions.
E-Mail: butchs@skoflo.com

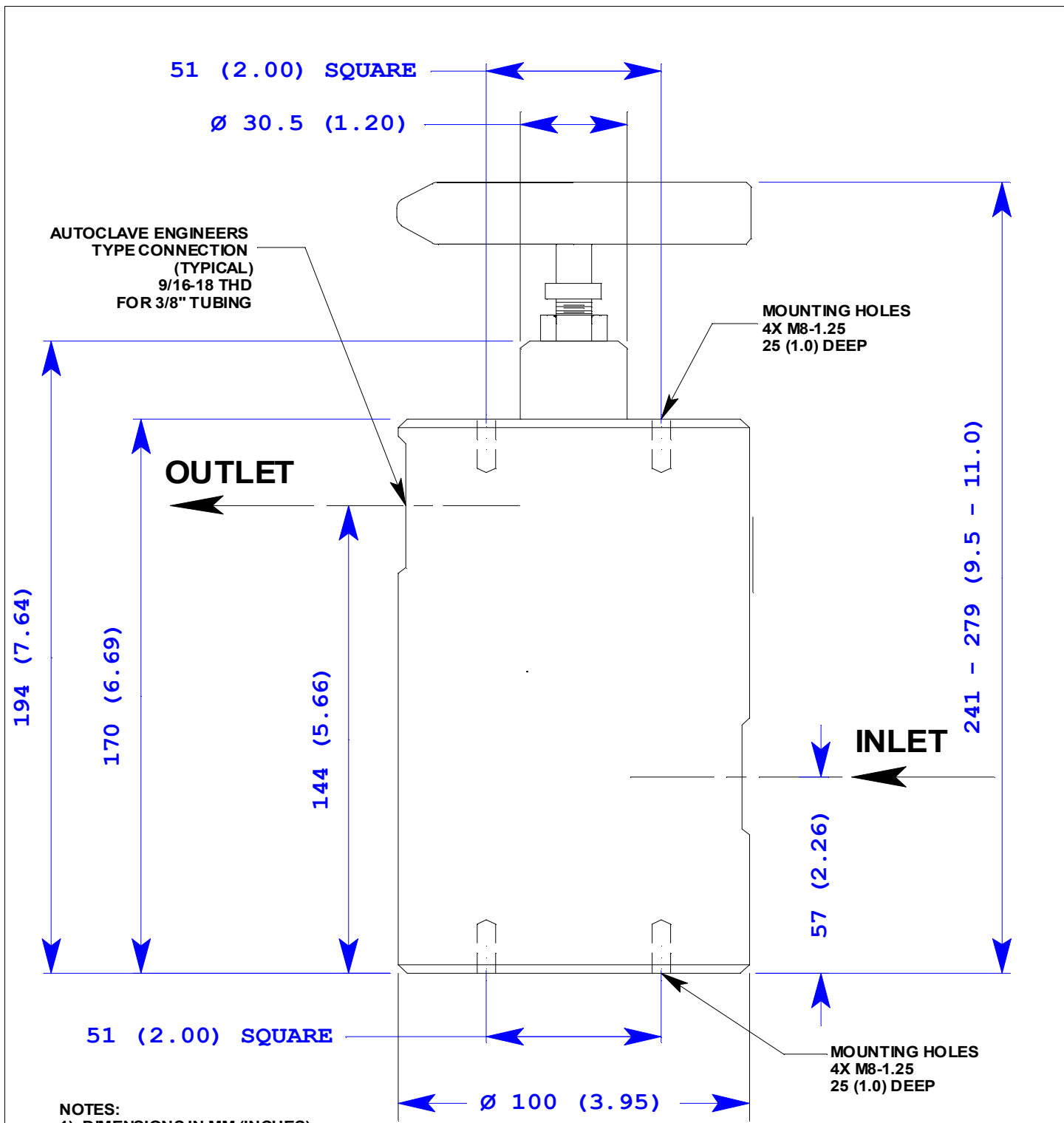

- NOTES:**
- 1) DIMENSIONS IN MM (INCHES)
 - 2) STANDARD MATERIALS:
 - BODY: Nitronic ss
 - SEAL: Graphite Fiber Reinforced PTFE
 - O-RING: Viton
 - BACKUP RING: PEEK
 - 3) ORIENTATION
INLET OPPOSITE SIDE OF OUTLET

SkoFlo Valve Model SF15000B		SkoFlo INDUSTRIES INC. Woodinville, WA	
SCALE:	NONE	DRAWN BY:	FJG
DATE:	9/12/00	REVISED:	3/3/04
OUTLINE DIMENSIONS		DRAWING NUMBER	REV
		SF-SK217	A

Multi-Point System Sample Schematic

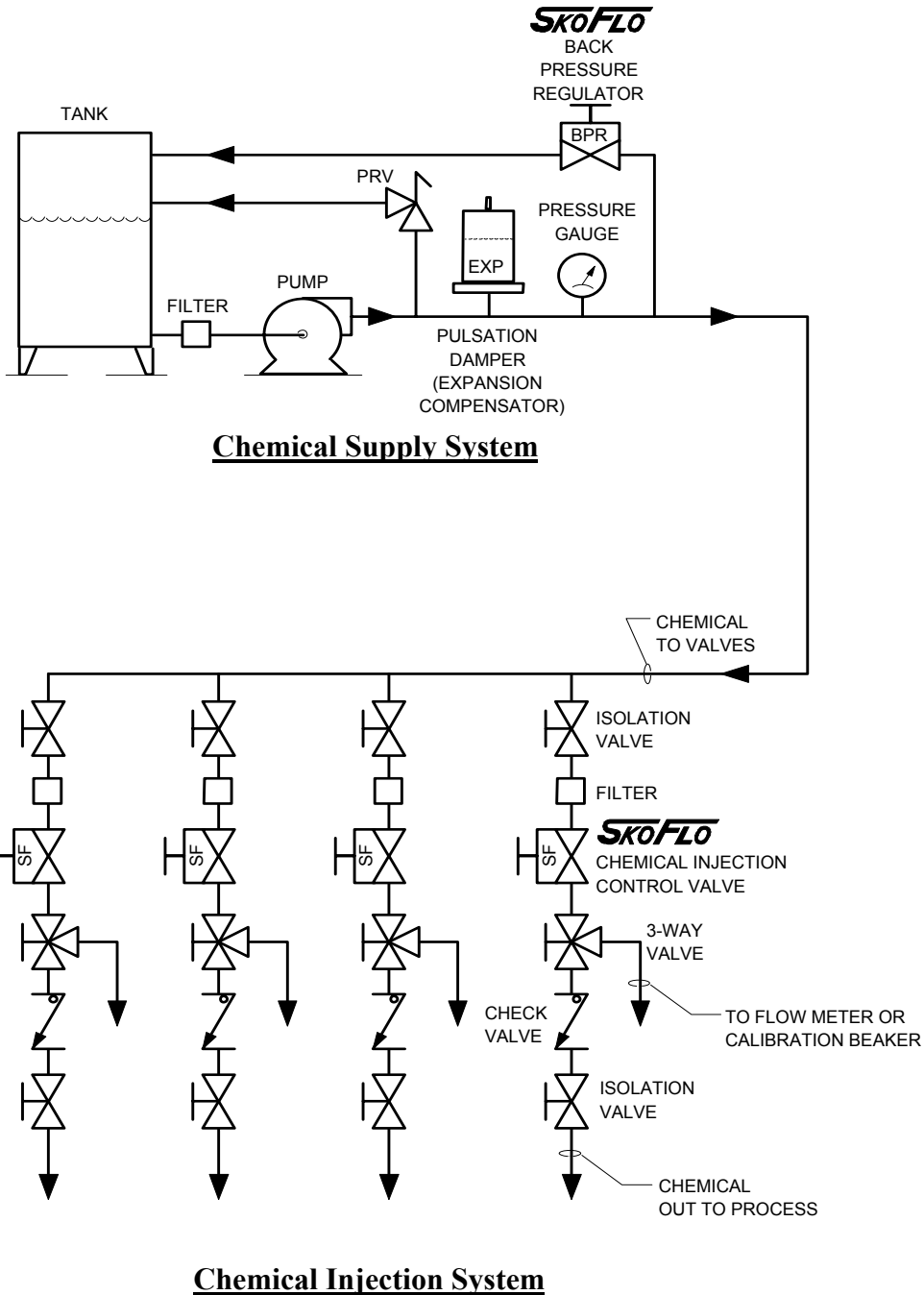

Notes:

1. Any number of injection points can be served by a single pump and header system. The only limitation is the flow capability of the pump.
2. Check valve must be installed within 5 feet from the SkoFlo valve.

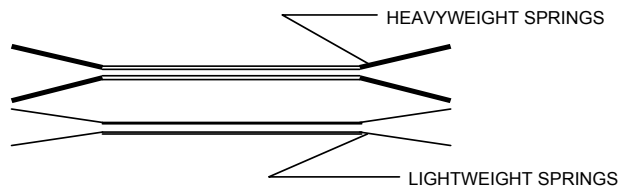
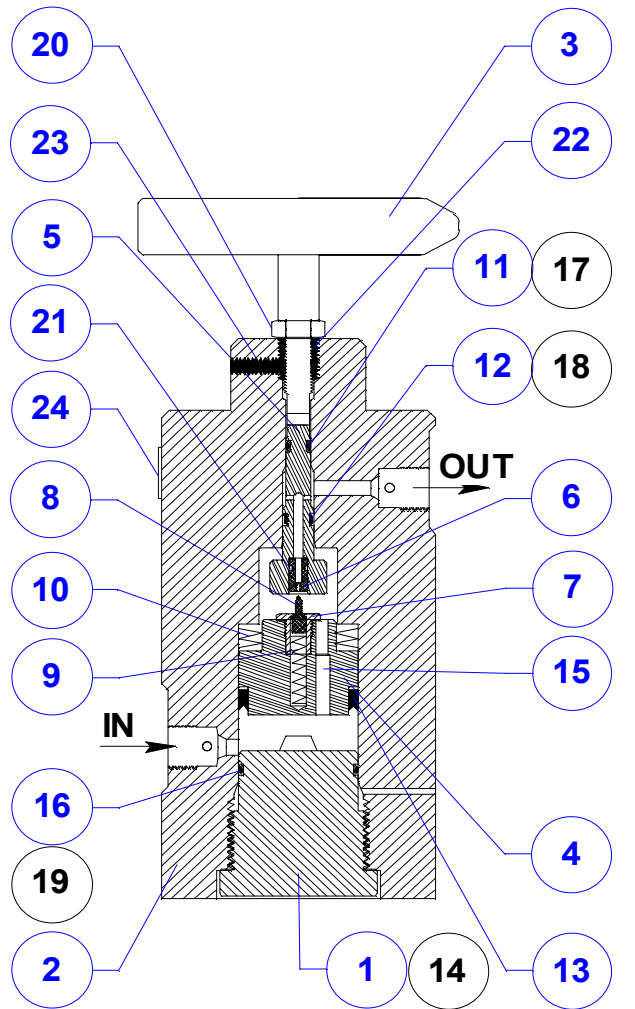

DETAIL A
PISTON SPRINGS

MATERIAL LIST - SkoFlo Valve SF15000B				
ITEM	QTY	PART NO.	DESCRIPTION	MATERIALS
1	1	BPR15000MFB-1-2S2	BASE CAP	316LSS
2	1	SF15000B-2	BODY	NITRONIC SS
3	1	SF15000B-3	RATE ADJUSTMENT HANDLE	316SS
4	1	SF5000C-4	PISTON	316LSS
5	1	SF15000B-5	SEAT HOLDER	316LSS
6	1	SF5000-6	SEAT	CERAMIC
7	1	SF5000C-7	PIN HOLDER	316LSS
8	1	SF5000-8	PIN	CERAMIC
9	1	SF5000-9	PIN SPRING	316SS
10	4	SF5000C-10	PISTON SPRING	316SS
11	1	SF15000B-11	O-RING (ATM)	VITON (KALREZ)
12	1	SF15000B-12	O-RING (SEAT HOLDER)	VITON (KALREZ)
13	1	SF5000-13	CUP SEAL (PISTON)	TEFLON w/ GRAPHITE FIBERS
14	1	SF10000D-14	SET SCREW (BASE)	GR A4 C80 SS
15	1	SF5000-15	ORIFICE	SS
16	1	SF15000B-16	O-RING (BASE TO BODY)	VITON (KALREZ)
17	1	SF15000B-27	BACK UP RING FOR ITEM 11	PEEK
18	1	SF15000B-28	BACK UP RING FOR ITEM 12	PEEK
19	1	SF15000B-29	BACK UP RING FOR ITEM 16	PEEK
20	1	SF5000C-17	LOCK NUT	316SS
21	1	SF5000C-18	O-RING (SEAT)	VITON (KALREZ)
22	1	SF5000C-19	HANDLE BUSHING	NI-BRONZE
23	1	SF15000B-35	STEM SET SCREW	316SS
24	1	SF15000-25	NAMEPLATE	302SS

- NOTES:
1. Cup seal (P/N SF5000-13) has a 316SS spring.
 2. Backup rings installed on low pressure side of o-rings
 3. O-ring materials in parenthesis () are "KALREZ" option
 4. Piston/Orifice (P/N SF5000C-4 & SF5000-15) and Seat/Pin parts (P/N SF15000B-5, SF5000-6, SF5000C-7 & SF5000-8) vary with model dash size.
 5. Piston springs (P/N SF5000C-10) include (2) lightweight and (2) heavyweight springs (see Detail A).

SkoFlo Valve Model SF15000B		SkoFlo INDUSTRIES INC. Woodinville, WA	
SCALE: NONE	APPROVED BY:	DRAWN BY: FJG	
DATE: 3/10/03		REVISED: 3/04/04	
SF15000B FLOW CONTROLLER ASSEMBLY SECTION / PARTS LIST		DRAWING NUMBER SF-0767	REV A

SKOFLO INDUSTRIES, INC.

www.skoflo.com

PO BOX 1728, 14241 NE 200th , Bldg A, Suite B
Woodinville Wa, 98072 USA
425.485.7816 FAX 425.368.1696

Our focus is on you our customer and for ISO 9001:2000 compliance we have prepared and request that you take the time to complete this **customer satisfaction survey**.

Company:	
Contact:	
Email:	
Phone:	

Please rate following categories	Highly Dissatisfied		N/A			Highly Satisfied	
	<input type="checkbox"/>	<input type="checkbox"/>	<input type="checkbox"/>	<input type="checkbox"/>	<input type="checkbox"/>	<input type="checkbox"/>	<input type="checkbox"/>
1. Product Quality	<input type="checkbox"/>	<input type="checkbox"/>	<input type="checkbox"/>	<input type="checkbox"/>	<input type="checkbox"/>	<input type="checkbox"/>	<input type="checkbox"/>
2. Product Features	<input type="checkbox"/>	<input type="checkbox"/>	<input type="checkbox"/>	<input type="checkbox"/>	<input type="checkbox"/>	<input type="checkbox"/>	<input type="checkbox"/>
3. Reliability	<input type="checkbox"/>	<input type="checkbox"/>	<input type="checkbox"/>	<input type="checkbox"/>	<input type="checkbox"/>	<input type="checkbox"/>	<input type="checkbox"/>
4. After sale support	<input type="checkbox"/>	<input type="checkbox"/>	<input type="checkbox"/>	<input type="checkbox"/>	<input type="checkbox"/>	<input type="checkbox"/>	<input type="checkbox"/>
5. Implementation	<input type="checkbox"/>	<input type="checkbox"/>	<input type="checkbox"/>	<input type="checkbox"/>	<input type="checkbox"/>	<input type="checkbox"/>	<input type="checkbox"/>
6. Delivery	<input type="checkbox"/>	<input type="checkbox"/>	<input type="checkbox"/>	<input type="checkbox"/>	<input type="checkbox"/>	<input type="checkbox"/>	<input type="checkbox"/>

Score from 1 (Low) to 7 (High)	(Low)		N/A			(High)	
	1	2	3	4	5	6	7
Recommend SkoFlo to friend or colleague.	<input type="checkbox"/>	<input type="checkbox"/>	<input type="checkbox"/>	<input type="checkbox"/>	<input type="checkbox"/>	<input type="checkbox"/>	<input type="checkbox"/>
Likely to Purchase Products from SkoFlo	<input type="checkbox"/>	<input type="checkbox"/>	<input type="checkbox"/>	<input type="checkbox"/>	<input type="checkbox"/>	<input type="checkbox"/>	<input type="checkbox"/>
Overall quality of relationship with SkoFlo	<input type="checkbox"/>	<input type="checkbox"/>	<input type="checkbox"/>	<input type="checkbox"/>	<input type="checkbox"/>	<input type="checkbox"/>	<input type="checkbox"/>
Overall level of satisfaction with SkoFlo	<input type="checkbox"/>	<input type="checkbox"/>	<input type="checkbox"/>	<input type="checkbox"/>	<input type="checkbox"/>	<input type="checkbox"/>	<input type="checkbox"/>
Overall level of satisfaction with respect to Product Valve	<input type="checkbox"/>	<input type="checkbox"/>	<input type="checkbox"/>	<input type="checkbox"/>	<input type="checkbox"/>	<input type="checkbox"/>	<input type="checkbox"/>
Overall level of satisfaction with respect to product engineering	<input type="checkbox"/>	<input type="checkbox"/>	<input type="checkbox"/>	<input type="checkbox"/>	<input type="checkbox"/>	<input type="checkbox"/>	<input type="checkbox"/>
Level of confidence of SkoFlo abilities to provide compliant product	<input type="checkbox"/>	<input type="checkbox"/>	<input type="checkbox"/>	<input type="checkbox"/>	<input type="checkbox"/>	<input type="checkbox"/>	<input type="checkbox"/>
Comments:							